

Vertical~25mm
Product Parts

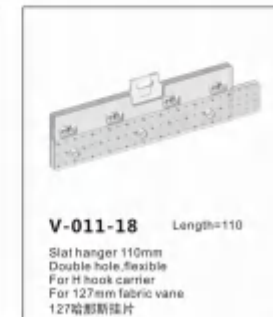

Vertical~25mm
Product Parts

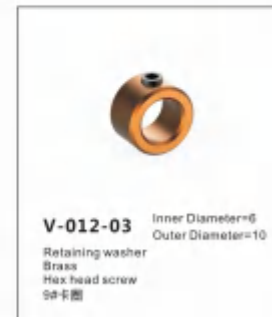
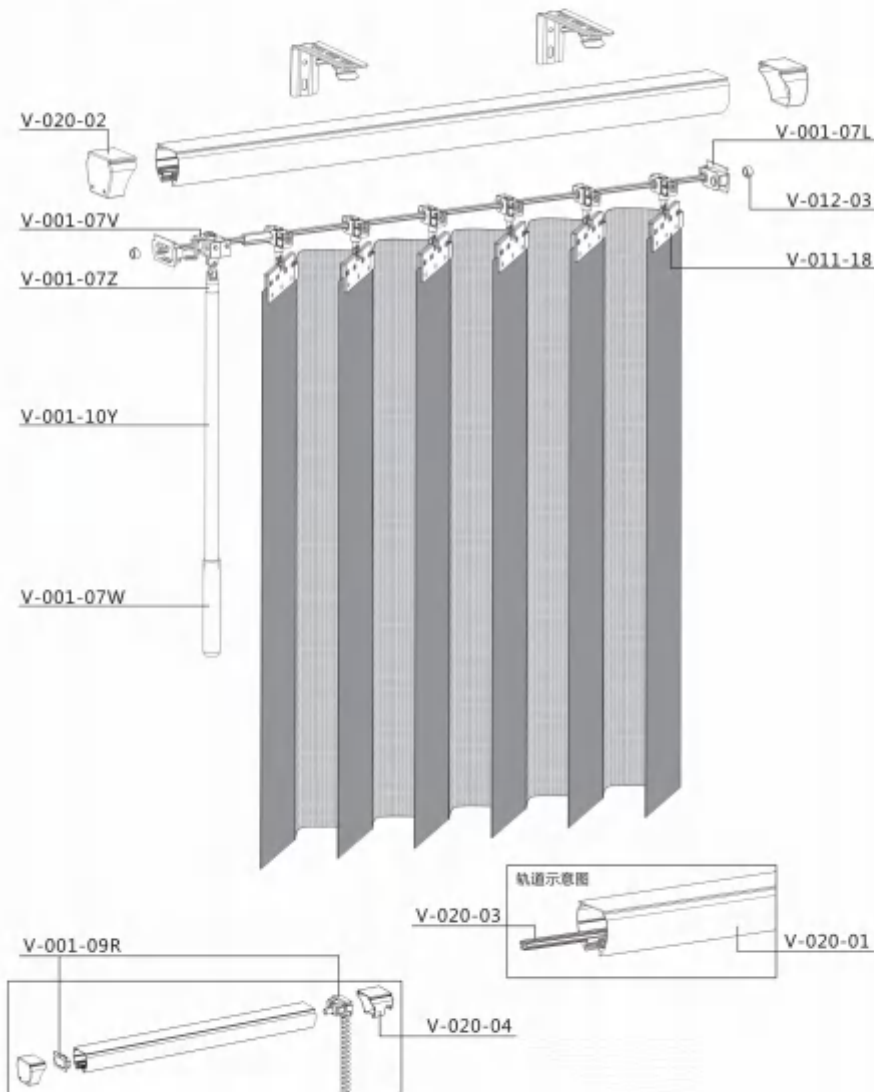
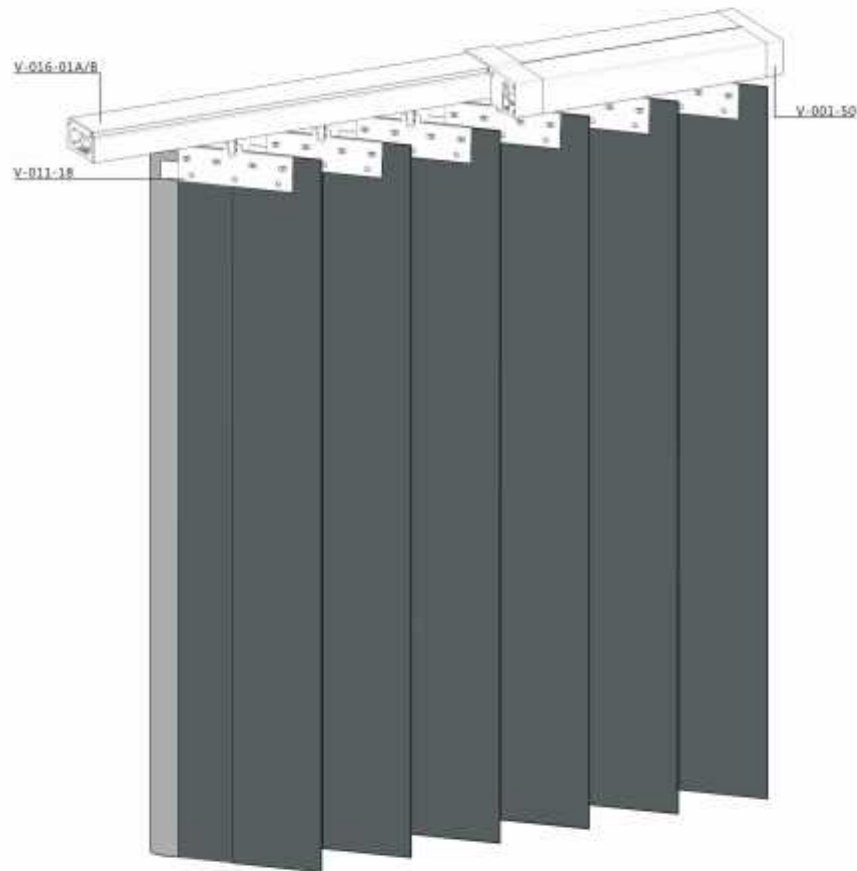

V-016-01A/B
Head track
Any length available
25毫米轨道



V-004-50
Card drive runner for motor system
电动卷带入孔



V-009-50
Plastic ball-chain for motor system
电动卷带链条



V-012-03 Inner Diameter=8
Outer Diameter=10
Retaining washer
Washer
Hex head screw
垫卡圈



V-001-50
Motor
电动卷带电机



V-011-18 Length=110
Slat hanger 110mm
Double hole possible
For 11mm carrier
For 127mm fabric vane
127毫米帘片



V-001-07D Height=25
End caps: 2#端盖
D type
For control mechanism



V-002-31D 1way
V-002-31C 2way
V-002-31A 3way
V-002-31B 4way
Carrier 31#连接



V-003-105
Length X=100
Perforated connecting sheet
105穿孔片

Vertical ~ 25mm
Product Parts

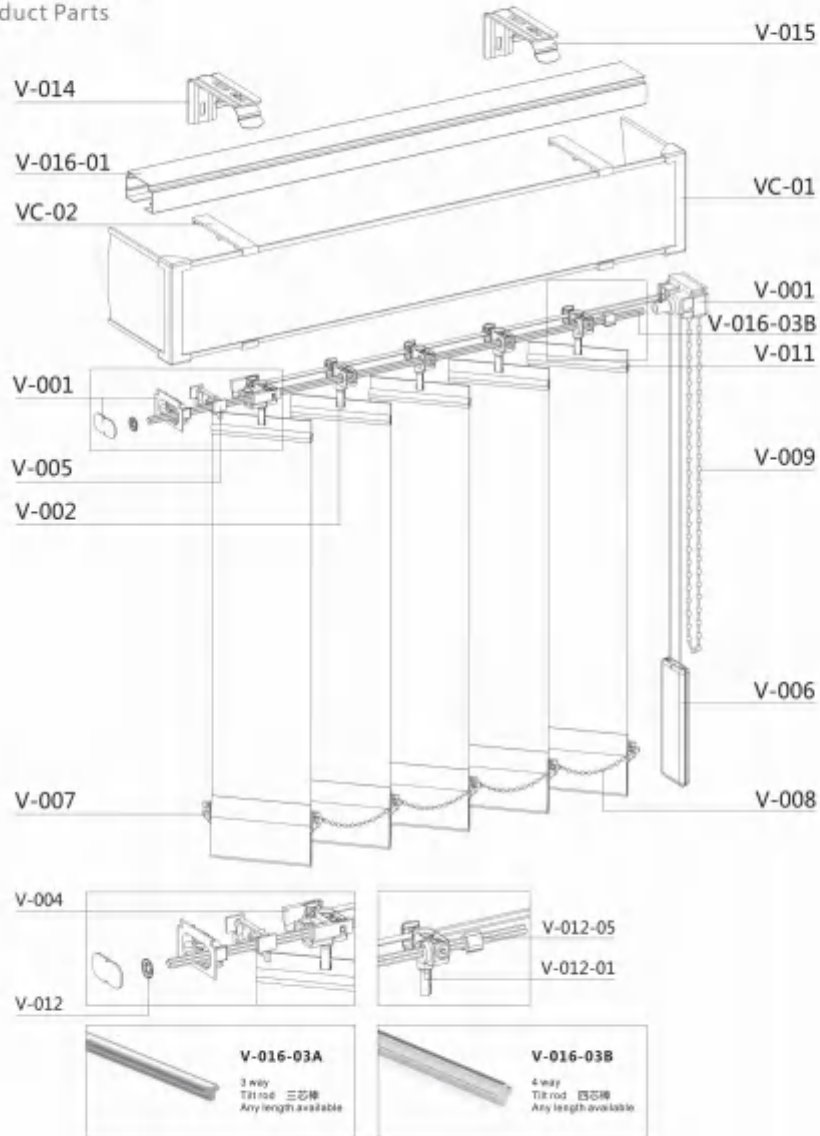

| | | |
|-------------------|-----------------|----------------------|
| V-016-01A | Thickness=0.8mm | Head track 25mm方轨道 |
| V-016-01AA | Thickness=0.7mm | 25mm opening |
| V-016-01AB | Thickness=0.9mm | Any length available |
| V-016-01AC | Thickness=1.0mm | Anodized |
| V-016-01B | Thickness=0.8mm | Head track 25mm方轨道 |
| V-016-01BA | Thickness=0.7mm | 25mm opening |
| V-016-01BB | Thickness=0.9mm | Any length available |
| V-016-01BC | Thickness=1.0mm | Painted white |

V-001-01R Plastic 塑芯
V-001-01TR Aluminium 铝芯
Control unit 1#制头(右)
For 25mm head track
Drive-right

V-001-03R Plastic 塑芯
Control unit 3#制头(右)
For 25mm head track
Drive-right

V-001-06R Plastic 塑芯
V-001-06TR Aluminium 铝芯
Control unit 6#制头(右)
For 25mm head track
Drive-right

V-001-08L Plastic 塑芯
V-001-08TL Aluminium 铝芯
Control unit 8#制头(左)
For 25mm head track
Drive-left

V-001-08R Plastic 塑芯
V-001-08TR Aluminium 铝芯
Control unit 8#制头(右)
For 25mm head track
Drive-right

V-001-17R Plastic 塑芯
Control unit 17#制头(右)
For 25mm head track
Drive-right

Vertical~25mm
Product Parts

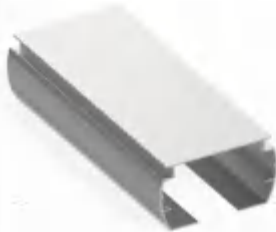

| | | |
|-------------------|-----------------|----------------------|
| V-016-04AA | Thickness=0.7mm | Head track 25mm圆形轨道 |
| V-016-04A | Thickness=0.8mm | 25mm opening |
| V-016-04AB | Thickness=0.9mm | Any length available |
| V-016-04AC | Thickness=1.0mm | Anodized |
| V-016-04BA | Thickness=0.7mm | Head track 25mm圆形轨道 |
| V-016-04B | Thickness=0.8mm | 25mm opening |
| V-016-04BB | Thickness=0.9mm | Any length available |
| V-016-04BC | Thickness=1.0mm | Painted white |

Vertical~33mm
Product Parts

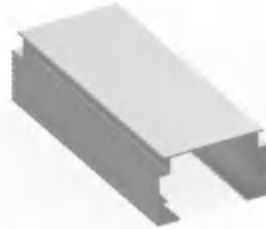

| | | |
|-------------------|-----------------|----------------------|
| V-016-07AA | Thickness=0.7mm | Head track 33mm方形轨道 |
| V-016-07A | Thickness=0.8mm | 33mm |
| V-016-07AB | Thickness=0.9mm | Any length available |
| V-016-07AC | Thickness=1.0mm | Anodized |
| V-016-07BA | Thickness=0.7mm | Head track 33mm方形轨道 |
| V-016-07B | Thickness=0.8mm | 33mm |
| V-016-07BB | Thickness=0.9mm | Any length available |
| V-016-07BC | Thickness=1.0mm | Painted white |



V-001-09L Plastic 塑芯

Control unit 9#制头(左)
For 25mm round head track
Drive-left



V-001-09R Plastic 塑芯

Control unit 9#制头(右)
For 25mm round head track
Drive-right



V-001-18L Plastic 塑芯

Control unit 18#制头(左)
For 25mm round head track
Drive-left



V-001-10R Plastic 塑芯

Control unit 10#制头(右)
For 33mm head track
Drive-right



V-001-05R Plastic 塑芯
V-001-05TR Aluminium 铝芯

Control unit 5#制头(右)
For 33mm head track
Drive-right



V-001-04R Plastic 塑芯
V-001-04TR Aluminium 铝芯

Control unit 4#制头(右)
For 33mm head track
Drive-right



V-001-16L Plastic 塑芯

Control unit 16#制头(左)
For 25mm round head track
Drive-right



V-001-16R Plastic 塑芯

Control unit 16#制头(右)
For 25mm round head track
Drive-right



V-001-18R Plastic 塑芯

Control unit 18#制头(右)
For 25mm round head track
Drive-right

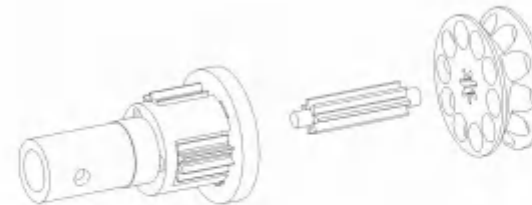

- V-001-01TR
- V-001-04TR
- V-001-05TR
- V-001-06TR
- V-001-08TR
- V-001-08TL
- V-001-13TR

Vertical~25/33mm
Product Parts

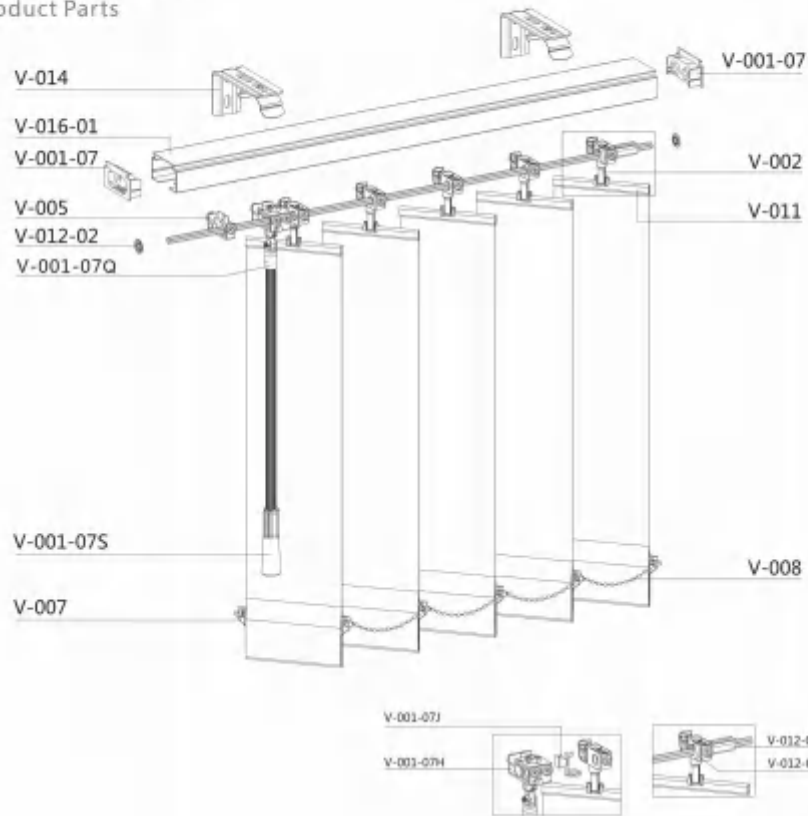

Narrow track parts
Product Parts

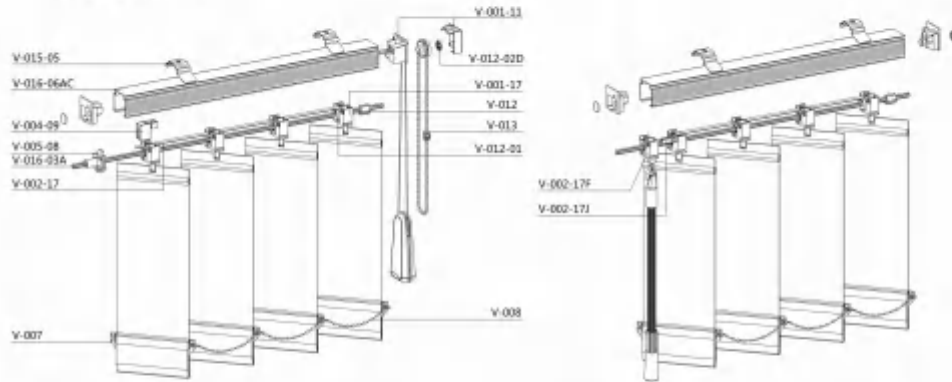

| | | | |
|--|-------------------|-----------------|---------------------------------------|
| | V-016-06AA | Thickness=0.8mm | Head track 窄轨窗帘轨道 |
| | V-016-06AB | Thickness=0.9mm | Narrow |
| | V-016-06AC | Thickness=1.0mm | Any length available Anodized |
| | V-016-06BA | Thickness=0.8mm | Head track 窄轨窗帘轨道 |
| | V-016-06BB | Thickness=0.9mm | Narrow |
| | V-016-06BC | Thickness=1.0mm | Any length available Painted white |

V-016-03A 3 way
Tilt rod 三芯棒
Any length available

V-001-11L Fasting 快速
Control unit 11#制头(左)
For narrow head track
Drive-left

V-001-11R Fasting 快速
Control unit 11#制头(右)
For narrow head track
Drive-right

V-005-08
Tilt rod support No.8 8#中托
For narrow head track

V-004-09
Cord drive runner No.9 9#孔/孔
3 parts(includes cord drive runner,
plastic cord grip and screw)

V-004-09A
Cord drive runner No.9 9#孔(带铁片)
4 parts(includes cord drive runner,
plastic cord grip, metal plate and screw)

V-005-08A
Tilt rod support No.8 8#中托(带磁铁)
With magnet
For narrow head track

V-001-07K
Stopper 固定销
For control mechanism

V-002-17J
HOOK adjust
窄轨转向器连接座

V-003-80
Spacer 80mm 80垫片
Plastic
For carrier

V-002-17D 1way
V-002-17C 2way
V-002-17A 3way
V-002-17B 4way
Carrier 17#生珠

V-002-17F 3way
Carrier
White J hook
For narrow profile head track
With plastic spacer
窄轨转向器

Narrow track parts
Product Parts



V-011-07
Slat hanger DIY 89mm
Single hole
For H hook carrier
For 89mm fabric vane
89毫米上挂片



V-007-02-1D Weight:32g±2g
Slat weight 89-5mm
Full plastic
For 89mm fabric vane



V-012-05 Length=10
V-012-06 Length=30
V-012-07 Length=18
V-012-09 Length=50
V-012-13 Length=25
Distance tube 距离管



V-014-04C Plated zinc 镀锌
V-014-04D Painted white 烤漆
Wall bracket 89mm
Thickness=1.8mm
89毫米矩形安装架



V-014-05C Plated zinc 镀锌
V-014-05D Painted white 烤漆
Wall bracket 127mm
Thickness=1.8mm
127毫米矩形安装架



V-014-10C Plated zinc 镀锌
V-014-10D Painted white 烤漆
Wall bracket 89mm
Thickness=2.0mm
89毫米安装架

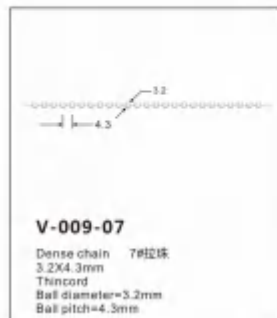

V-009-07
Dense chain 7#拉珠
3.2X4.3mm
Thinrod
Ball diameter=3.2mm
Ball pitch=4.3mm

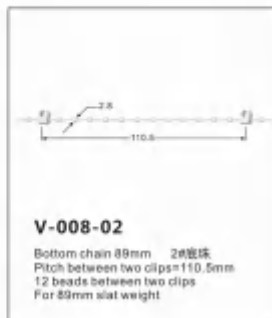

V-008-02
Bottom chain 89mm 2#拉珠
Pitch between two clips=110.5mm
12 beads between two clips
For 89mm slat weight



V-012-02D nickel plated 镀镍
Lock washer 8#卡圈
Toothed internal
For 3way or 4way Tilt rod
Diameter=11.6



V-014-11C Plated zinc 镀锌
V-014-11D Painted white 烤漆
Wall bracket 127mm
Thickness=2.5mm
127毫米安装架



V-014-01A Plated zinc 镀锌
V-014-01B Painted white 烤漆
Wall bracket 89mm
Thickness=1.5mm
1#安装架



V-014-02A Plated zinc 镀锌
V-014-02B Painted white 烤漆
Wall bracket 127mm
Thickness=1.5mm
2#安装架



V-013-15 For 3.2 plastic chain
Chain connector
15#球扣



V-015-20A Plated zinc 镀锌
V-015-20B Painted white 烤漆
Ceiling clip 20#卡簧
Thickness=0.6mm



V-006-04 Weight=60g
Cord weight
With metal
4#手磅



V-001-07W
Wand holder
For Control rod
哈那斯手柄套



V-001-07Z
Wand holder
For Control rod
哈那斯手柄套



V-001-10Y
Control rod
Any length available
Aluminum
Hollow
12.8mm外径

Carrie
Product Parts



V-002-04D 1way
V-002-04C 2way
V-002-04A 3way
V-002-04B 4way
 Carrier 4#走珠



V-002-08D 1way
V-002-08C 2way
V-002-08A 3way
V-002-08B 4way
 Carrier 8#走珠



V-002-11D 1way
V-002-11C 2way
V-002-11A 3way
V-002-11B 4way
 Carrier 11#走珠



V-002-26D 1way
V-002-26C 2way
V-002-26A 3way
V-002-26B 4way
 Carrier 26#走珠



V-002-28D 1way
V-002-28C 2way
V-002-28A 3way
V-002-28B 4way
 Carrier 28#走珠



V-002-30D 1way
V-002-30C 2way
V-002-30A 3way
V-002-30B 4way
 Carrier 30#走珠



V-002-15D 1way
V-002-15C 2way
V-002-15A 3way
V-002-15B 4way
 Carrier 15#走珠



V-002-16D 1way
V-002-16C 2way
V-002-16A 3way
V-002-16B 4way
 Carrier 16#走珠



V-002-17D 1way
V-002-17C 2way
V-002-17A 3way
V-002-17B 4way
 Carrier 17#走珠



V-002-31D 1way
V-002-31C 2way
V-002-31A 3way
V-002-31B 4way
 Carrier 31#走珠



V-002-32D 1way
V-002-32C 2way
V-002-32A 3way
V-002-32B 4way
 Carrier 32#走珠



V-002-33D 1way
V-002-33C 2way
V-002-33A 3way
V-002-33B 4way
 Carrier 33#走珠



V-002-22 3way
 Carrier 22#走珠



V-002-24D 1way
V-002-24C 2way
V-002-24A 3way
V-002-24B 4way
 Carrier 24#走珠



V-002-25A Clear H hook
V-002-25B White H hook
 Carrier 25#走珠



V-002-34D 1way
V-002-34C 2way
V-002-34A 3way
V-002-34B 4way
 Carrier 34#走珠



V-002-34D 1way
V-002-34C 2way
V-002-34A 3way
V-002-34B 4way
 Carrier 34#走珠

Spacer
Product Parts



V-003-75 length X=75
V-003-80 length X=80
V-003-82 length X=82
V-003-90 length X=90
V-003-105 length X=105
V-003-112 length X=112
V-003-115 length X=115

Connector 垫片



V-003-T
Spacer adapter
垫片调节器



V-003-75Z
Length X=75
Pored connecting sheet
75开孔垫片



V-003-80Z
Length X=79.8
Pored connecting sheet
80开孔垫片



V-003-80ZA
Length X=80.4
Pored connecting sheet
80.4开孔垫片



V-003-115Z
Length X=115.4
Pored connecting sheet
115开孔垫片



V-003-80M length X=80
V-003-75AM length X=75
V-003-115BM length X=115
V-003-116M length X=116
 Stainless steel 钢垫片

Cord drive runner
Product Parts



V-004-01
Cord drive runner 1#八爪
Universal in low and high profile
Unassembled
head track



V-004-01A
Cord drive runner 1#八爪(带铁片)
With connector(Steel plated zinc)
Universal in low and high profile
head track



V-004-02
Cord drive runner 2#八爪
Universal in low and high profile
Unassembled
head track



V-004-06
Cord drive runner 6#八爪
Universal in low and high profile
Unassembled
head track



V-004-06A
Cord drive runner 6#八爪(带铁片)
With connector(Steel plated zinc)
Universal in low and high profile
head track



V-004-07
Cord drive runner 7#八爪
Universal in low and high profile
head track



V-004-03
Cord drive runner 3#八爪
Universal in low and high profile
head track



V-004-10
Cord drive runner 10#八爪(带铁片)
With connector(Steel plated zinc)
Universal in low and high profile
head track





V-004-04
Steel sheet 7字铁片
L type
Used with tilt rod support

Tilt rod support Product Parts

| | | |
|---|---|--|
|  <p>V-005-01 Tilt rod support 1#中托 Universal in low and high profile head track</p> |  <p>V-005-02A Tilt rod support 2#中托(带磁铁) With magnet Universal in low and high profile head track</p> |  <p>V-005-02 Tilt rod support 2#中托 Universal in low and high profile head track</p> |
|  <p>V-005-03A Tilt rod support 3#中托(带磁铁) With magnet Universal in low and high profile head track</p> |  <p>V-005-03 Tilt rod support 3#中托 Universal in low and high profile head track</p> |  <p>V-005-06 Tilt rod support 6#中托 Universal in low and high profile head track</p> |
|  <p>V-005-07 Tilt rod support 7#中托 Universal in low and high profile head track</p> |  <p>V-005-09 Tilt rod support 9#中托 Universal in low and high profile head track</p> |  <p>V-005-11 Tilt rod support 11#中托 Universal in low and high profile head track</p> |

Bottom chain Product Parts

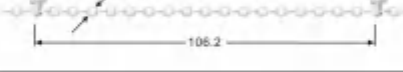
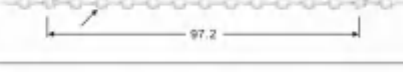
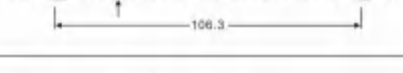
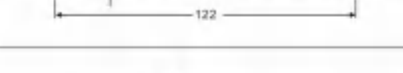
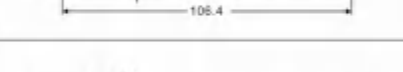
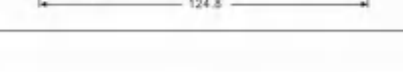
| | | |
|---|------------------|---|
|  | V-008-01 | Bottom chain 127mm 1#底珠 Pitch between two clips=141mm 16 beads between two clips For 127mm slot weight |
|  | V-008-02 | Bottom chain 89mm 2#底珠 Pitch between two clips=110.5mm 12 beads between two clips For 89mm slot weight |
|  | V-008-03 | Bottom chain 127mm 3#底珠 Pitch between two clips=141.9mm 21 beads between two clips For 127mm slot weight |
|  | V-008-04 | Bottom chain 89mm 4#底珠 Pitch between two clips=108.2mm 17 beads between two clips For 89mm slot weight |
|  | V-008-05 | Bottom chain 89mm 5#底珠 Pitch between two clips=97.2mm 11 beads between two clips For 89mm slot weight |
|  | V-008-06A | Bottom chain 115mm 6#A底珠 Pitch between two clips=106.3mm 9 beads between two clips For 100mm slot weight |
|  | V-008-06B | Bottom chain 125mm 6#B底珠 Pitch between two clips=122mm 10 beads between two clips For 100mm slot weight |
|  | V-008-07A | Bottom chain 89mm 7#A底珠 Pitch between two clips=106.4mm 7 beads between two clips For 89mm slot weight |
|  | V-008-07B | Bottom chain 89mm 7#B底珠 Pitch between two clips=124.8mm 12 beads between two clips For 89mm slot weight |

Bottom chain
Product Parts

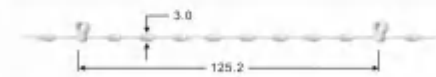

V-008-08A

Bottom chain 127mm 8#A底珠
Pitch between two clips=125.2mm
8 beads between two clips
For 127mm slat weight



V-008-08B

Bottom chain 127mm 8#B底珠
Pitch between two clips=145mm
14 beads between two clips
For 127mm slat weight

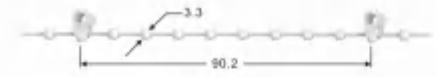

V-008-09

Bottom chain 89mm 9#底珠
Pitch between two clips=90.2mm
8 beads between two clips
For 89mm slat weight



V-008-10

Bottom chain 127mm 10#底珠
Pitch between two clips=127.5mm
12 beads between two clips
For 127mm slat weight

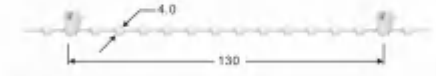

V-008-11

Bottom chain 127mm 11#底珠
Pitch between two clips=130mm
12 beads between two clips
For 127mm slat weight

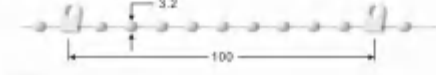

V-008-12

Bottom chain 89mm 12#底珠
Pitch between two clips=100mm
9 beads between two clips
For 89mm slat weight

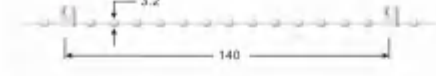

V-008-13

Bottom chain 127mm 13#底珠
Pitch between two clips=140mm
14 beads between two clips
For 127mm slat weight

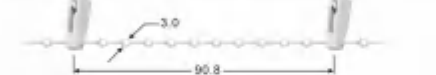

V-008-14

Bottom chain 89mm 14#底珠
Pitch between two clips=90.8mm
10 beads between two clips
For 89mm slat weight



V-008-15

Bottom chain 115mm 15#底珠
Pitch between two clips=112mm
12 beads between two clips
For 89mm slat weight



V-008-16

Bottom chain 127mm 16#底珠
Pitch between two clips=143.4mm
8 beads between two clips
For 127mm slat weight



V-008-17

Bottom chain 17#底珠
3.2x52mm
Pitch between two clips=51.6mm
3 beads between two clips
For PVC



V-008-18

Bottom chain 18#底珠
3.2x59mm
Pitch between two clips=59mm
6 beads between two clips
For PVC

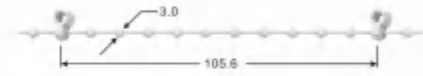

V-008-19

Bottom chain 89mm 19#底珠
Pitch between two clips=105.6mm
10 beads between two clips
For 89mm slat weight

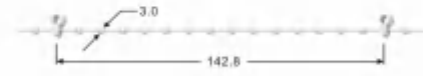

V-008-21

Bottom chain 127mm 21#底珠
Pitch between two clips=142.8mm
14 beads between two clips
For 127mm slat weight

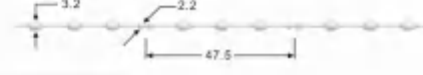

V-008-22

Bottom chain 22#底珠
Pitch between two clips=47.5mm
3 beads between two clips
For PVC

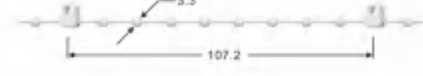

V-008-24

Bottom chain 89mm 24#底珠
Pitch between two clips=107.2mm
8 beads between two clips
For 89mm slat weight

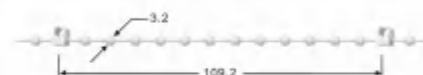

V-008-25

Bottom chain 89mm 25#底珠
Pitch between two clips=109.2mm
12 beads between two clips
For 89mm slat weight

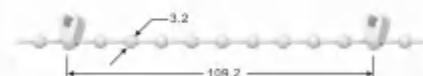

V-008-26

Bottom chain 89mm 26#底珠
Pitch between two clips=108.2mm
9 beads between two clips
For 89mm slat weight



Bottom chain
Product Parts

| | | |
|--|-----------------|---|
| | V-008-27 | Bottom chain 89mm 27颗底珠 Pitch between two clips=90mm 8 beads between two clips For 89mm slot weight |
| | V-008-28 | Bottom chain 89mm 28颗底珠 Pitch between two clips=94.2mm 11 beads between two clips For 89mm slot weight |
| | V-008-30 | Bottom chain 89mm 30颗底珠 Steel ball Pitch between two clips=102mm For 89mm slot weight |
| | V-008-31 | Bottom chain 127mm 31颗底珠 Steel ball Pitch between two clips=127mm For 127mm slot weight |
| | V-008-32 | Bottom chain 89mm 32颗底珠 Pitch between two clips=96mm 9 beads between two clips For 89mm slot weight |
| | V-008-33 | Bottom chain 127mm 33颗底珠 Pitch between two clips=135mm 13 beads between two clips For 127mm slot weight |
| | V-008-34 | Bottom chain 89mm 34颗底珠 Pitch between two clips=94.8mm 12 beads between two clips For 89mm slot weight |
| | V-008-35 | Bottom chain 89mm 35颗底珠 Pitch between two clips=83mm 6 beads between two clips For 89mm slot weight |
| | V-008-36 | Bottom chain 127mm 36颗底珠 Pitch between two clips=118.5mm 9 beads between two clips For 127mm slot weight |

Chain
Product Parts

| | | |
|--|--------------------------------------|---|
| | V-009-05 | Steel chain 4.5*6钢拉珠 4.5X6mm Ball diameter=4.5mm Ball pitch=6mm Metal chain with nickel |
| | V-009-05B | Steel chain 4.5*6不锈钢拉珠 4.5X6mm Ball diameter=4.5mm Ball pitch=6mm Stainless steel ball chain |
| | V-009-01A V-009-01B | Sparse chain 4.5*12精拉珠 4.5X12mm Thick cord Ball diameter=4.5mm Ball pitch=12mm |
| | V-009-02 | Dense chain 4.5*6粗绳密拉珠 4.5X6mm Thick cord Ball diameter=4.5mm Ball pitch=6mm |
| | V-009-03 | Dense chain 4.5*6细绳密拉珠 4.5X6mm Thin cord Ball diameter=4.5mm Ball pitch=6mm |
| | V-009-04 | Dense chain 4.5*6透明密拉珠 4.5X6mm Thick cord Color=clear Ball diameter=4.5mm Ball pitch=6mm |
| | V-009-06 | Dense chain 7.3*10.3大拉珠 7.3X10.3mm Thick cord Color=clear Ball diameter=7.3mm Ball pitch=10.3mm |
| | V-009-07 | Dense chain 3.2*4.3拉珠 3.2X4.3mm Thin cord Ball diameter=3.2mm Ball pitch=4.3mm |
| | V-009-08 | Sparse chain 3.2*8拉珠 3.2X8mm Thin cord Ball diameter=3.2mm Ball pitch=8mm |

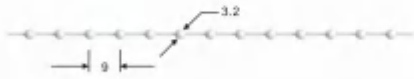
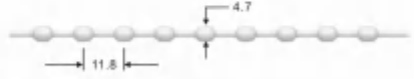
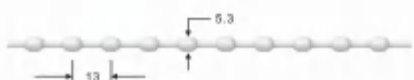
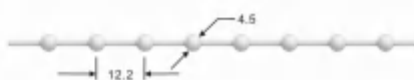
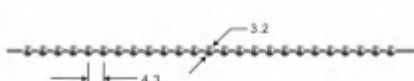
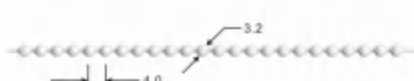
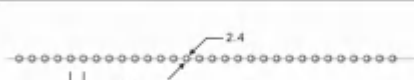
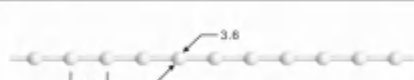
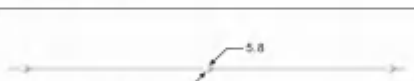
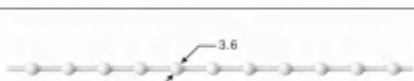
Chain Product Parts

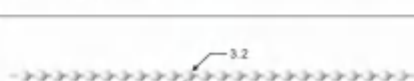
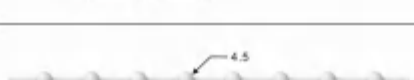
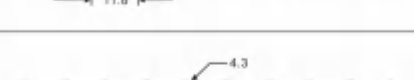
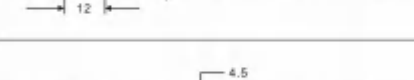
| | | | | | |
|---|-----------------|---|---|-----------------|--|
|  | V-009-09 | Sparse chain 3.2×9拉珠 3.2X9mm Thin cord Ball diameter=3.2mm Ball pitch=9mm |  | V-009-22 | Chain 4.7×11.8米拉珠 4.7X11.8mm Thick cord Rice shape Ball diameter=4.7mm Ball pitch=11.8mm |
|  | V-009-10 | Chain rice shape 5.3×13米拉珠 5.3X13mm Thick cord Ball diameter=5.3mm Ball pitch=13mm |  | V-009-23 | Sparse chain 4.5×12.2拉珠 4.5X12.2mm Thick cord Ball diameter=4.5mm Ball pitch=12.2mm |
|  | V-009-15 | Steel chain 3.2×4.3钢拉珠 3.2X4.3mm Ball diameter=3.2mm Ball pitch=4.3mm |  | V-009-24 | Dense chain 3.2×4拉珠 3.2X4.0mm Thin cord Ball diameter=3.2mm Ball pitch=4.0mm |
|  | V-009-16 | Steel chain 2.4×3.5钢拉珠 2.4X3.5mm Ball diameter=2.4mm Ball pitch=3.5mm |  | V-009-31 | Dense chain 3.8×9拉珠 3.8X9.0mm Thin cord Ball diameter=3.8mm Ball pitch=9.0mm |
|  | V-009-17 | Chain 5.8×115钢拉珠 5.8X115mm Ball diameter=5.8mm Ball pitch=115mm |  | V-009-32 | Dense chain 3.6×9拉珠 3.6X9.0mm Thin cord Ball diameter=3.6mm Ball pitch=9.0mm |
|  | V-009-18 | Chain 5.8×94钢拉珠 5.8X94mm Ball diameter=5.8mm Ball pitch=94mm |  | V-009-33 | Dense chain 3.2×4.2拉珠 3.2X4.2mm Thin cord Ball diameter=3.2mm Ball pitch=4.2mm |
|  | V-009-19 | Sparse chain 4.5×11.8拉珠 4.5X11.8mm Thick cord Ball diameter=4.5mm Ball pitch=11.8mm | | | |
|  | V-009-20 | Chain 4.3×12钢拉珠 4.3X12mm Thick cord Ball diameter=4.3mm Ball pitch=12mm | | | |
|  | V-009-21 | Chain 4.5×12米拉珠 4.5X12mm Thick cord Rice shape Ball diameter=4.5mm Ball pitch=12mm | | | |

Chain connector
Product Parts



V-013-01 For 4.5 plastic chain
Chain connector
1298[1]



V-013-03 For 4.5 plastic chain
Chain connector
3498[1]



V-013-02 For 4.5 plastic chain
Chain connector
2498[1]



V-013-15 For 3.2 plastic chain
Chain connector
15498[1]



V-013-16 For 3.2 plastic chain
Chain connector
16498[1]



V-013-20 For 3.2 plastic chain
Chain connector
20498[1]



V-013-04 For 4.5 plastic chain
Chain connector
4498[1]



V-013-05 For 7.3 plastic chain
Chain connector
5498[1]



V-013-06 For 7.3 plastic chain
Chain connector
6498[1]



V-013-09 For 4.5 steel chain
Chain connector
9498[1]



V-013-10 For 3.2 steel chain
Chain connector
10498[1]



V-013-11 For 2.4 steel chain
Chain connector
11498[1]



V-013-07 For 3.2 plastic chain
Chain connector
7498[1]



V-013-08 For 4.5 plastic chain
Chain connector
8498[1]



V-013-14 For 4.5 plastic chain
Chain connector
14498[1]

Cord weight
Product Parts



Slat weight
Product Parts

| | | | | | |
|---|---|---|---|---|---|
|  <p>V-007-02-5 Weight:24g±2g Slat weight 89-1鍍鉄 Full plastic For 89mm fabric vane</p> |  <p>V-007-02-1E Weight:28g±2g V-007-02-6 Weight:30g±2g V-007-02-1B Weight:32g±2g Slat weight 89-2鍍鉄 Full plastic For 89mm fabric vane</p> |  <p>V-007-02-15 Weight:28g±2g V-007-02-1A Weight:32g±2g V-007-02-2 Weight:36g±2g V-007-02-3 Weight:38g±2g Slat weight 89-3鍍鉄 Full plastic For 89mm fabric vane</p> |  <p>V-007-02-13 Weight:28g±2g Slat weight 89-11鍍鉄 Full plastic For 89mm fabric vane</p> |  <p>V-007-02-14 Weight:32g±2g Slat weight 89-12鍍鉄 Full plastic For 89mm fabric vane</p> |  <p>V-007-02-16 Weight:32g±2g Slat weight 89-12鍍鉄 Full plastic For 89mm fabric vane</p> |
|  <p>V-007-02-1C Weight:32g±2g V-007-02-10 Weight:38g±2g Slat weight 89-4鍍鉄 Full plastic For 89mm fabric vane</p> |  <p>V-007-02-1D Weight:32g±2g Slat weight 89-5鍍鉄 Full plastic For 89mm fabric vane</p> |  <p>V-007-02-4 Weight:32g±2g Slat weight 89-6鍍鉄 Full plastic For 89mm fabric vane</p> |  <p>V-007-02-17 Weight:32g±2g Slat weight 89-13鍍鉄 Full plastic For 89mm fabric vane</p> |  <p>V-007-02-18 Weight:32g±2g Slat weight 89-14鍍鉄 Full plastic For 89mm fabric vane</p> |  <p>V-007-02-19 Weight:38g±2g Slat weight 89-15鍍鉄 Full plastic For 89mm fabric vane</p> |
|  <p>V-007-02-8 Weight:32g±2g Slat weight 89-8鍍鉄 Full plastic For 89mm fabric vane</p> |  <p>V-007-02-9 Weight:38g±2g Slat weight 89-9鍍鉄 Full plastic For 89mm fabric vane</p> |  <p>V-007-02-11 Weight:32g±2g Slat weight 89-10鍍鉄 Full plastic For 89mm fabric vane</p> |  <p>V-007-03-1 Weight:32g±2g Slat weight 100-1鍍鉄 Full plastic For 100mm fabric vane</p> |  <p>V-007-03-2 Weight:42g±2g Slat weight 100-2鍍鉄 Full plastic For 100mm fabric vane</p> |  <p>V-007-03-3 Weight:24g±2g Slat weight 100-3鍍鉄 Full plastic For 100mm fabric vane</p> |



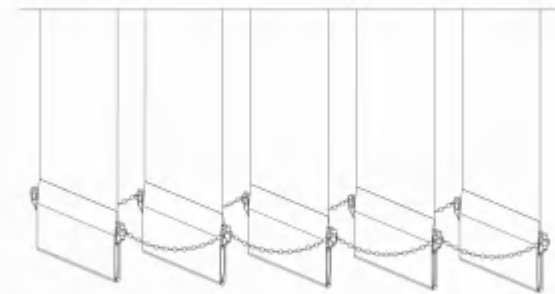



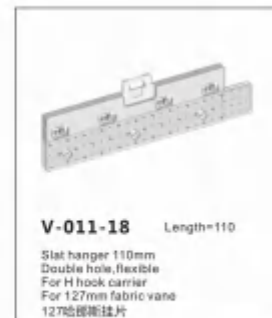











Slat weight
Product Parts



Slat hanger
Product Parts



Stop ring/Lock washer
Product Parts

| | | | | | |
|---|---|---|--|--|--|
|  <p>V-012-01A Stop ring 1#介子 Plastic For 3way or 4way Tilt rod</p> |  <p>V-012-01B Stop ring 2#介子 Plastic For 3way or 4way Tilt rod</p> |  <p>V-012-01C Stop ring 3#介子 Plastic For 3way or 4way Tilt rod</p> |  <p>V-012-02A3 black Lock washer 5#卡圈 Toothed internal For 3way or 4way Tilt rod Diameter=14.5</p> |  <p>V-012-02A4 black Lock washer 6#卡圈 Toothed internal For 3way or 4way Tilt rod Diameter=12.6</p> |  <p>V-012-02A5 nickel plated 镀镍 Lock washer 7#卡圈 Toothed internal For 3way or 4way Tilt rod Diameter=11.6</p> |
|  <p>V-012-01D Stop ring 4#介子 Plastic For 3way or 4way Tilt rod</p> |  <p>V-012-01F black Stop ring 5#介子 For 3way or 4way Tilt rod</p> |  <p>V-012-02A1 black V-012-02B1 nickel plated 镀镍 Lock washer 1#卡圈 Toothed internal For 3way or 4way Tilt rod Diameter=12.6</p> |  <p>V-012-02D nickel plated 镀镍 Lock washer 8#卡圈 Toothed internal For 3way or 4way Tilt rod Diameter=11.6</p> |  <p>V-012-03 Inner Diameter=6 Outer Diameter=10 Retaining washer 8#卡圈 Brass Hex head screw</p> |  <p>V-012-05 Length=10 V-012-06 Length=30 V-012-07 Length=18 V-012-09 Length=50 V-012-13 Length=25 Distance tube 距离管 Plastic</p> |
|  <p>V-012-02A2 black V-012-02B2 nickel plated 镀镍 Lock washer 2#卡圈 Toothed internal For 3way or 4way Tilt rod Diameter=11.6</p> |  <p>V-012-03B Lock washer 3#卡圈 For 3way or 4way Tilt rod Inner diameter=6 Plastic</p> |  <p>V-012-02B3 nickel plated 镀镍 Lock washer 4#卡圈 Toothed internal For 3way or 4way Tilt rod Diameter=15.4</p> |  <p>V-012-04C plated zinc 镀锌 Stopper R型销 For retaining washer</p> |  <p>V-012-04A Diameter=2.3 Rod pin 1#固定销 Spring pin black Without slot</p> |  <p>V-012-04B Diameter=2.3 Rod pin 2#固定销 Spring pin slotted black With slot</p> |

Track connector
Product Parts

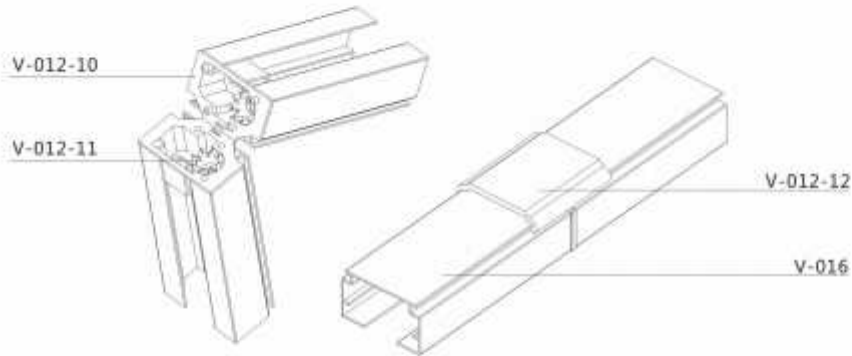

Valance parts
Product Parts

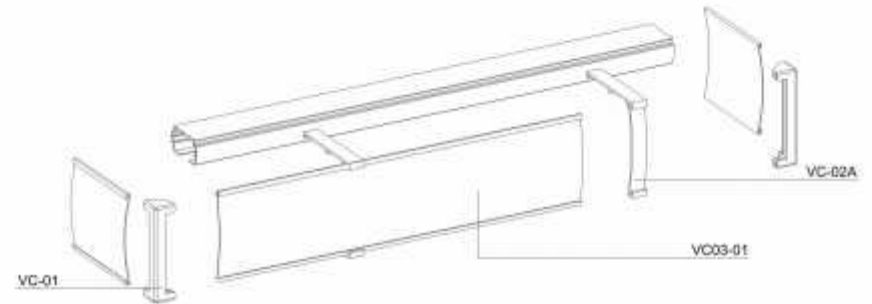

| | | | |
|--|-------------------|-----------------|----------------------|
| | V-016-01A | Thickness=0.8mm | Head track 25mm宽方轨道 |
| | V-016-01AA | Thickness=0.7mm | 25mm opening |
| | V-016-01AB | Thickness=0.9mm | Any length available |
| | V-016-01AC | Thickness=1.0mm | Anodized |
| | V-016-01B | Thickness=0.8mm | Head track 25mm宽方轨道 |
| | V-016-01BA | Thickness=0.7mm | 25mm opening |
| | V-016-01BB | Thickness=0.9mm | Any length available |
| | V-016-01BC | Thickness=1.0mm | Painted white |



Trapezium hook
Product Parts



Bracket
Product Parts



V-014-01A Plated zinc 镀锌
V-014-01B Painted white 烤漆
Wall bracket 89mm
Thickness=1.5mm
1#安装架



V-014-02A Plated zinc 镀锌
V-014-02B Painted white 烤漆
Wall bracket 127mm
Thickness=1.5mm
2#安装架



V-014-03A Plated zinc 镀锌
V-014-03B Painted white 烤漆
Wall bracket 127mm
Thickness=1.5mm
3#安装架



V-014-10A Plated zinc 镀锌
V-014-10B Painted white 烤漆
Wall bracket 89mm
Thickness=2.0mm
10#安装架



V-014-11A Plated zinc 镀锌
V-014-11B Painted white 烤漆
Wall bracket 127mm
Thickness=2.0mm
11#安装架



V-014-12A Plated zinc 镀锌
Wall bracket 89mm
With ceiling clip
Thickness=2.0mm
12#安装架



V-014-04A Plated zinc 镀锌
V-014-04B Painted white 烤漆
Wall bracket 89mm
Thickness=1.8mm
4#安装架



V-014-04E Plated zinc 镀锌
V-014-04F Painted white 烤漆
Wall bracket 127mm
Thickness=1.8mm
4#异形安装架



V-014-05A Plated zinc 镀锌
V-014-05B Painted white 烤漆
Wall bracket 127mm
Thickness=1.8mm
5#安装架



V-014-13A Plated zinc 镀锌
Wall bracket 89mm
With ceiling clip
Thickness=2.0mm
13#安装架



V-014-14A Plated zinc 镀锌
V-014-14B Painted white 烤漆
Wall bracket 127mm
Thickness=1.5mm
14#安装架



V-014-23A Plated zinc 镀锌
V-014-23B Painted white 烤漆
Wall bracket 127mm
Thickness=1.5mm
23#安装架



V-014-05E Plated zinc 镀锌
V-014-05F Painted white 烤漆
Wall bracket 127mm
Thickness=1.8mm
127异形安装架



V-014-08A Plated zinc 镀锌
V-014-08B Painted white 烤漆
Wall bracket 89mm
Thickness=1.5mm
6#安装架



V-014-09A Plated zinc 镀锌
V-014-09B Painted white 烤漆
Wall bracket 127mm
Thickness=1.5mm
9#安装架



V-014-28A Plated zinc 镀锌
V-014-28B Painted white 烤漆
Wall bracket 127mm
Thickness=1.5mm
28#安装架



V-014-34 Plated zinc 镀锌
Painted white 烤漆
Wall bracket 127mm
Thickness=1.5mm
34#安装架

Bracket
Product Parts



Ceiling clip
Product Parts

| | | | | | |
|--|--|--|---|---|---|
|  <p>V-015-01A Plated zinc 镀锌 V-015-01B Painted white 烤漆 Ceiling clip Thickness=0.6mm 1#卡簧</p> |  <p>V-015-02A Plated zinc 镀锌 V-015-02B Painted white 烤漆 Ceiling clip Thickness=0.6mm 2#卡簧</p> |  <p>V-015-03A Plated zinc 镀锌 V-015-03B Painted white 烤漆 Ceiling clip Thickness=0.5mm 3#卡簧</p> |  <p>V-015-15 Plated zinc 镀锌 Painted white 烤漆 Ceiling clip Thickness=0.6mm 15#卡簧</p> |  <p>V-015-16 Plated zinc 镀锌 Painted white 烤漆 Ceiling clip Thickness=0.5mm 16#卡簧</p> |  <p>V-015-17 Plated zinc 镀锌 Painted white 烤漆 Ceiling clip Thickness=0.6mm 17#卡簧</p> |
|  <p>V-015-04A Plated zinc 镀锌 V-015-04B Painted white 烤漆 Ceiling clip Thickness=0.6mm 4#卡簧</p> |  <p>V-015-06A Plated zinc 镀锌 V-015-06B Painted white 烤漆 Ceiling clip Thickness=0.6mm 6#卡簧</p> |  <p>HV25 Plated zinc 镀锌 HV25-1 Painted white 烤漆 Ceiling clip Thickness=0.6mm 7#卡簧</p> |  <p>V-015-18 Plated zinc 镀锌 Painted white 烤漆 Ceiling clip Thickness=0.6mm 18#卡簧</p> |  <p>V-015-19 Plated zinc 镀锌 Painted white 烤漆 Ceiling clip Thickness=0.6mm 19#卡簧</p> |  <p>V-015-20A Plated zinc 镀锌 V-015-20B Painted white 烤漆 Ceiling clip Thickness=0.6mm 20#卡簧 (新)</p> |
|  <p>V-015-08A Plated zinc 镀锌 V-015-08B Painted white 烤漆 Ceiling clip Thickness=0.6mm 8#卡簧</p> |  <p>V-015-09A Plated zinc 镀锌 V-015-09B Painted white 烤漆 Ceiling clip Thickness=0.6mm 9#卡簧</p> |  <p>V-015-10A Plated zinc 镀锌 V-015-10B Painted white 烤漆 Ceiling clip Thickness=0.6mm 10#卡簧</p> |  <p>V-015-21 Plated zinc 镀锌 Painted white 烤漆 Ceiling clip Thickness=0.6mm 14#卡簧</p> |  <p>V-015-22 Plated zinc 镀锌 Painted white 烤漆 Ceiling clip Thickness=0.6mm 22#卡簧</p> |  <p>V-015-23 Plated zinc 镀锌 Painted white 烤漆 Ceiling clip Thickness=0.6mm 23#卡簧</p> |